

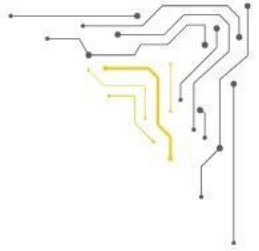

Helios – Gen III Gear Box

The Solutions Company



Helios Redesigned Gear Box

Areas redesigned with Engineering precision:

- **Housing redesigned for better balance and precision alignment**
- **Zero axial play**
- **Precision bearing fit (high precision tolerances)**
- **Precision gear lash**
- **Gears are billet and 316L**
- **Gear contact area doubled from OEM**
- **Aerospace grade gear concentricity**
- **New mounting configuration feature allows for improved installation / efficiency**

All dimensions and manufacturing techniques are proprietary to Helios

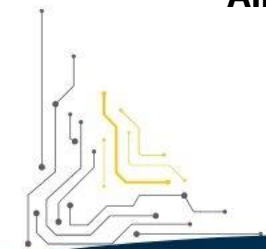

- **Designed to exceed latest OEM specification**
- **Tested for manufacturing precision**
- **Shaft / gears hobbled from 316L billet**
- **Precision timing / parallelism**
- **Gear contact area doubled for extended life**
- **Precision gear lash**
- **Zero axial play**
- **Aerospace grade gear concentricity**
- **High precision tolerance (bearing fit)**
- **Krytox 240AC lubricated**
- **Mounting feature for installation improved for user efficiency**
- **Drop in replacement**
- **Comes with high quality ferro seal**
- **Levels of service**
- **L2 –gear clusters replaced**
- **L3 –new, redesigned and improved**

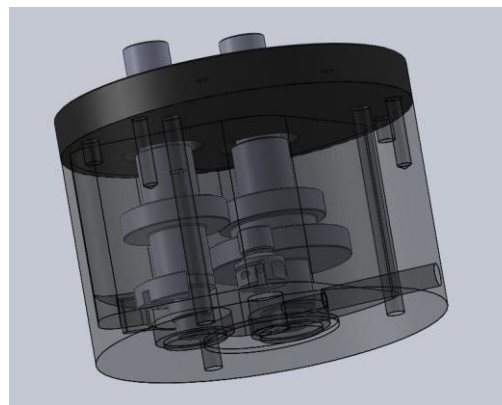

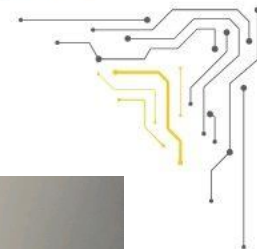

Helios Gear Box GEN III

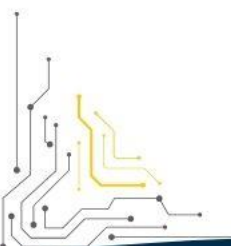



Helios Gear Box GEN III

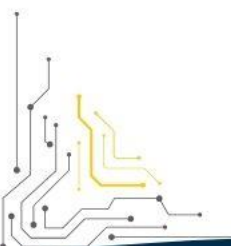



Helios Gear Box GEN III

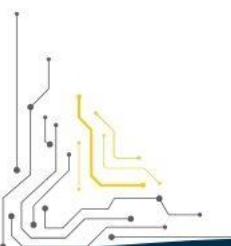
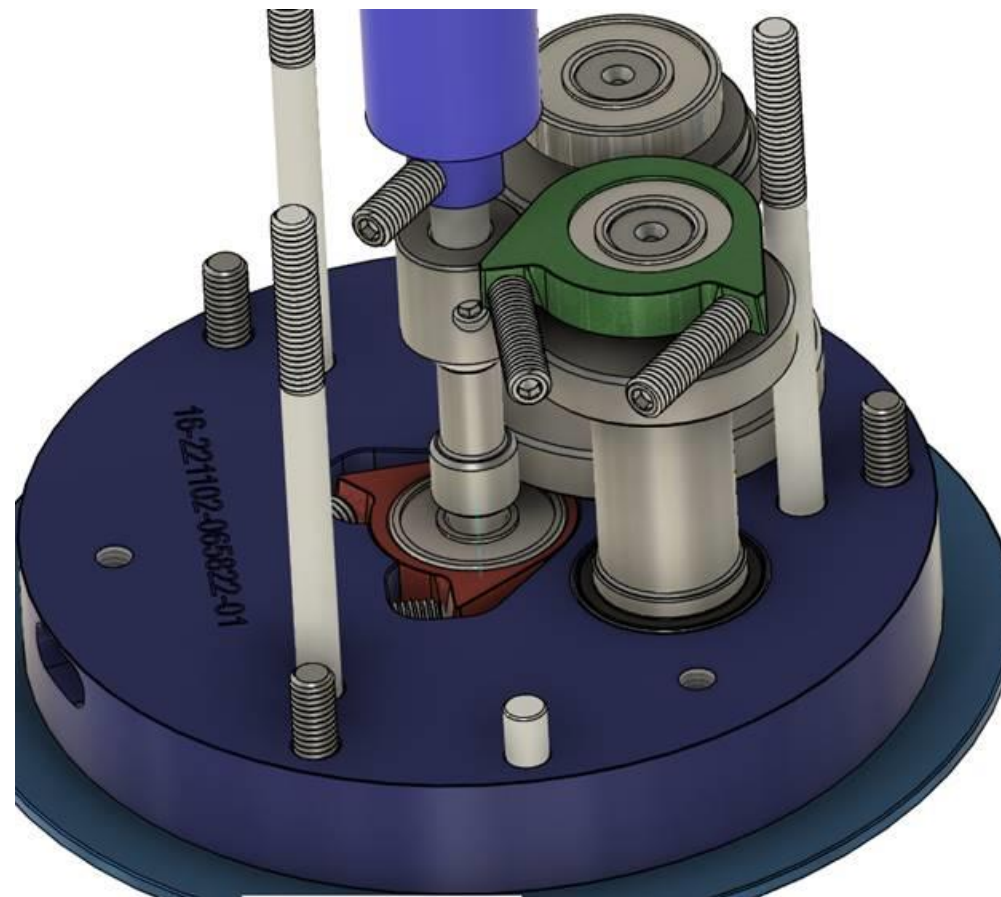



Helios Gear Box GEN III





Helios Gear Box GEN III

